



Individual & Neighbourhood

ALL-HAZARD

Emergency Preparedness
Workbook



BRITISH
COLUMBIA
Ministry of Public Safety
and Solicitor General



National Library of Canada cataloguing in publication data

Main entry under title:

Individual & neighbourhood all-hazard emergency preparedness workbook

At head of title: Emergency preparedness, get ready.

ISBN 0-7726-4750-X

1. Emergency management - British Columbia.
2. Emergency management. 3. Survival skills. I. British Columbia. Provincial Emergency Program. II. Title: Individual and neighbourhood all-hazard emergency preparedness workbook.

HV551.5.C32I52 2002

363.34'7'09711

C2002-960074-X

ALL-HAZARD

Emergency Preparedness Workbook

TABLE OF CONTENTS

ACKNOWLEDGEMENTS	iv
INTRODUCTION	iv
HAZARDS IN BRITISH COLUMBIA	iv
1. PREPARING YOUR FAMILY FOR A DISASTER	1
Guide to Family Safety	1
Tips for the Elderly and/or Disabled	3
Lessening Your Children's Fears	4
• Prepare in Advance	4
Caring for Your Pets in an Emergency	4
2. THE FAMILY EMERGENCY PLAN	5
Reuniting Your Family	5
Emergency Evacuation	6
Evacuation of Seniors and/or Disabled	7
3. IMPORTANT FAMILY AND INDIVIDUAL INFORMATION	8
Legal and Financial Information	8
• Name and Social Insurance Numbers of All Family Members	8
• Bank Accounts	8
• Insurance Policies	9
• Vehicle Registration Numbers	9
Emergency Supply Kit Information	10
• Names of Household Members (including boarders)	10
• Employment Information	10
• School Information	10
• Medical Contacts	11
• Personal Medical Information	11
• Other Important Numbers	12
4. EMERGENCY SUPPLY KITS	13
Home Emergency Kit	13
• Food Supplies	13
- Infant Needs	14
- Food Related Supplies	15

• Water Provisions	15
- Additional Sources of Water	16
- Purification Techniques	16
• First Aid Supplies	17
- Medicine	17
- Medical Equipment	17
- Bandages	17
• Additional Supplies	18
- Clothing	18
- Lighting	18
- Other Necessary Items	19
Pet Emergency Kit	19
Vehicle Emergency Kit	20
• Personal Supplies	20
• Vehicle Supplies	20
Workplace Emergency Kit	21
5. SANITATION	22
Disposing of Human Wastes	22
Handling Garbage	23
6. HAZARDS/EMERGENCY PREPAREDNESS	24
Earthquakes	24
• Before an Earthquake	24
• Home Hazard Hunt	25
• During an Earthquake	32
- In Your Home, Workplace or Other Building	32
- In a High-Rise Building	32
- In Shopping Malls and Other Public Places	32
- Outdoors	32
- In a Vehicle	32
- On a Bus or Train	33
- On a Boat or Ferry	33
- Seniors and/or Disabled	33
• After an Earthquake	33
Tsunamis	33
• Preparing for a Tsunami	34
• During a Tsunami	34
Floods	35
• Before a Flood	35
• When Flooding Occurs	35
- If Outdoors	35
- In a Vehicle	35
- In Your Home	36
• Flood Threat Precautions	36

- Electrical Service	36
- Electrical Appliances	36
- Gas or Oil Furnaces and Appliances	36
- Plumbing Fixtures and Water Supplies	36
- Other Precautions	37
- Sandbagging	37
Landslides and/or Avalanches	38
• Landslide	38
- Indoors	38
- If Outside	38
• Avalanche	38
- Recommended Equipment for Avalanche Areas	39
• Preparing Your Home and Property for a Landslide or Avalanche	39
Forest Fires and Interface Fires	40
• Protecting Your Property	40
• In an Interface Fire	41
• If Trapped in a Forest Fire	41
Severe Storms	41
• Thunderstorm	41
• Hailstorm	41
• Lightning Storm	42
• Severe Rainstorm	42
• Tornado	42
• Blizzard or Snowstorm	42
• Protecting Your Property Against a Severe Storm	43
Power Outages	43
• During a Power Outage	43
• Power Generators	45
• Fallen Power Lines	46
Hazardous Materials	46
• When a Hazardous Spill Occurs	46
Volcanoes	47
• Protection from Volcanic Activity	48
7. MOBILE HOME PREPAREDNESS	49
8. AFTER A DISASTER	50
Addressing Your Children's Needs	50
If you had to Leave Your Home	51
9. WEB SITES, RESOURCES AND REFERENCES	52
Additional Sources of Information	53

ACKNOWLEDGEMENTS

This workbook was originally developed as an earthquake preparedness publication by the Greater Victoria Emergency Coordinator's Committee. Because British Columbia is a province of many hazards the workbook has been updated as an all-inclusive guide to family emergency planning. The workbook now covers additional hazards such as floods, forest fires, landslides, severe storms, and tsunamis.

This workbook, and other materials that provide information about individual and neighbourhood safety, has been developed in co-operation, and with the support of, various agencies, groups and individuals such as: the Greater Victoria Emergency Preparedness Committee, Thrifty Foods, Coast Capital Credit Union, Honda City, TTC Design Group Inc., BC Transit, BC Gas, BC Hydro, Telus, BC Housing, the Credit Association of Victoria, Roger's Cable, First Aid & Survival Technologies (FAST), JJM Group, Puget Sound Power and Light Company, the Strengthening Preparedness Among Neighbors (SPAN) Program, the Justice Institute of B.C., individuals and first responders.

The Justice Institute of B.C. also produces a companion guide, the Neighbourhood Emergency Preparedness: Program Guide, to help communities create and sustain neighbour helping neighbour programs.

INTRODUCTION

The diverse climate and land base of our province affords a variety of potential disasters. In an emergency, telephone, gas, electricity and water services may be disrupted for days. Roads could be blocked and stores and gas stations closed. Being aware of the dangers and the best ways in which to lessen their impact is the core of emergency preparedness.

This workbook provides information and useful guidelines to help you protect your family and property. When a disaster strikes, there won't be time to find flashlight batteries or replace missing first aid supplies; the time to prepare, is NOW!

HAZARDS IN BRITISH COLUMBIA

It is important to know the dangers that exist in your community and to design your Family Emergency Plan with those hazards in mind. Earthquakes, tsunamis, floods, landslides, avalanches, interface fires, severe storms and hazardous material spills are some of the dangers that could threaten lives and cause extensive damage in our province.

ALL-HAZARD

Emergency Preparedness Workbook

Section 1

PREPARING YOUR FAMILY FOR A DISASTER

Make safety a natural part of your lifestyle. When a crisis occurs, you'll be thankful for that list of emergency numbers on your fridge, for knowing your family's daily schedule and for having an emergency kit ready to use.

Although we can't prevent natural disasters from happening, we can prepare to avoid injury, minimize damage and come through the clean-up period as quickly and comfortably as possible.

GUIDE TO FAMILY SAFETY

- Contact your local authority to find out if there is a Neighbourhood Emergency Program or Block Watch Program to assist residents in preparing for a disaster.
- Check with local authorities to find out what hazards could occur in your area and the impact they could have.
- Develop a Family Emergency Plan that addresses these issues and suits your family's individual needs and limitations.
- Sketch the floor plan of your home showing the two main exit routes and an alternate second exit from each room if possible.
- Keep your Family Emergency Plan in a visible place, such as the front of your refrigerator. Share your plan with your neighbours. Be sure to go through the steps with anyone who stays in your home.
- Mark on your plan the date it was prepared and update any changes in your household when they occur.
- Assign specific safety tasks to family members (e.g. one person responsible for gathering pets, one person responsible for first aid, etc.).
- Practice your Family Emergency Plan until everyone is sure of their role and keep it current by practicing every six months. Rehearsing can be fun, quality time with your family.

- For earthquake safety, you can go through your home with the Home Hazard Hunt checklist and take measures that make your home safer.
- Prepare an Emergency Supply Kit to keep your family self sufficient for a minimum of 72 hours. Be sure to include any special needs items you may require.
- Also have Emergency Supply Kits in your vehicles and at your workplace.
- Mark the areas where any special medical equipment, the Emergency Supply Kit and the fire extinguishers are kept.
- Your family may not be together at home when an emergency occurs. So plan a family meeting place that's central to most of your regular away-from-home spots.
- In some emergency situations, local phone service may be limited. Plan to have an out-of-area telephone contact where all family members can check in, in case you are separated.
- Check your insurance policies to ensure you have all the coverage you need for fires, earthquakes, flooding, etc.
- Knowing how to use a ham radio can be a valuable asset in a crisis. Consider taking a course, especially if you live in an isolated area.
- Take first aid classes and keep your training current.
- Keep your vehicle in good repair and keep your gas tank at least half full.
- Stay in touch with the world around you. This will keep you informed of any impending dangers to your community, such as a possible flood. When warnings occur, do a quick run through of the Family Emergency Plan and stay tuned to the radio or TV.

TIPS FOR THE ELDERLY and/or DISABLED

The information given in this workbook applies to everyone, but additional precautions should be taken for those who are elderly and/or disabled. Family Emergency Plans should always include any special needs considerations:

- If you live alone, get to know your neighbours and choose (if possible) two people you trust to be your helpers during an emergency. Explain your special needs, and share your Emergency Plan with them, show them how to operate any medical equipment you use, and practice your emergency procedures.
- Adapt home safety measures to suit your needs. For example, safety clips on cupboards may not be appropriate for your particular disability; experiment with other options, such as elastics joining drawer knobs together.
- Keep extra emergency supplies at your bedside or by your wheelchair if you have mobility problems.
- Keep your walking aids near you at all times, and, if possible, an extra cane or walking aid in different rooms at home and at work. If you have a seeing eye dog, keep a cane handy as well, as your dog may be injured or too frightened to help you during a major disaster like an earthquake.
- In your Emergency Supply Kit, remember to include extra prescription medications and any medical equipment you use, such as catheters or inner tubes for your wheelchair.
- Keep a whistle and small flashlight near you as this will help others find you in an emergency situation. The international signal for help is three short blasts.



LESSENING YOUR CHILDREN'S FEARS

Your children's recovery time will be reduced if they understand the dangers of a hazardous situation and are practiced and comfortable with their role in the Family Emergency Plan.

PREPARE IN ADVANCE

Talk with your children about what to expect during and after a disaster. For example use the resources of your local library for books and videos on earthquakes or floods. The goal is to create awareness, not to frighten them.

- Emphasize that they are learning to be safe when you practice the Family Emergency Plan together and allow them to react.
- Be sure they are adept at finding the safe place in each room and identify the safe places in their outside play areas.
- Ask your children's school about their disaster response plans. If the school holds the children until a parent picks them up, explain this to your children so they'll know this in advance.
- Choose a friend or relative close to the school who will care for your children if you're unable to leave your location when the disaster strikes. Make sure that your children and the school know who this is.

CARING FOR YOUR PETS IN AN EMERGENCY

Your pets won't be able to fend for themselves in the event of an emergency and it is your responsibility to protect and care for them. Be sure your pet has a current I.D. tag, licence or identifying tattoo. When possible, keep your pet with you and remember that your pet will be frightened and confused. If it is necessary to evacuate your house, be aware that pets are **not allowed** in most emergency shelters. If you must leave your pet in the house, confine your animal to one room with plenty of water and dry food.

ALL-HAZARD

Emergency Preparedness Workbook

Section 2

THE FAMILY EMERGENCY PLAN

Preparedness is not a one-time activity but a continuous process; keep your family's plan in mind whenever you rearrange your house, change the building structure or family members leave home or move in.

REUNITING YOUR FAMILY

The home of a nearby friend, a local school or church are possible reunion locations. If separated in a crisis, having a prearranged site will decrease both time and stress involved in bringing your family back together. Be sure to leave a note in a visible area if you decide to leave your home for this site!

Reunion Site: #1 _____

Reunion Site: #2 _____

During an emergency, long distance phone service is often easier to obtain than local service. Choose someone who lives at least 160 kilometres (100 miles) away who has voice-mail or an answering machine as your out-of-area contact.

Out-of-Area Contact: _____

Area Code & Phone Number: _____

Keep this information on a small card in your Emergency Supply Kit and in each family member's purse, wallet or backpack.

When a disaster strikes, if family members are separated, each person should call the out-of-area contact person, tell this person where they are and how they are doing and arrange a future check-in time. As everyone checks in, the stress of worrying about your loved ones will be reduced and it will also prevent needless searching for those already safe.

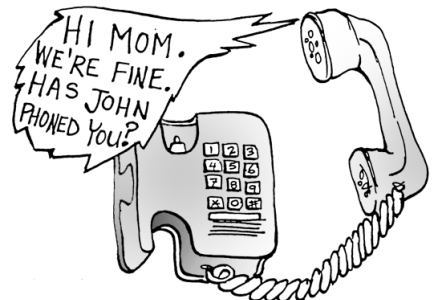

EMERGENCY EVACUATION

In the event of a major disaster or threat to your home, you'll need to be prepared to evacuate quickly and efficiently. Sketch the floor plan of your home and establish two exit routes. Be sure everyone knows how to leave safely out of an upstairs window if your home is multi-level. By planning and practicing what to do before a disaster strikes you'll have prepared your family to react in a safer manner at the first sign of danger.

People with respiratory problems or who are pregnant should be removed from smoke or fumes quickly.

List the **most important** items to be taken with you and only those that can be hand carried.

If your home is severely damaged or if there is an order to evacuate because of flooding, interface fires, etc., here are some things you should do:

- Vacate your home when advised to do so by local emergency authorities. Ignoring this warning could jeopardize not only the lives of your family members but also those who try to rescue you.
- Ensure that each member of your family has warm clothing and waterproof footwear and outerwear.
- Ensure that each family member has identification, especially your children. Name tags on their clothing, wallet cards and wristband are useful in case you are separated from them.
- If a different meeting place than agreed on in your Emergency Plan is necessary, make sure every member of your household knows where the new location is. Provide your younger children with a note sealed in plastic stating the family's destination.
- Make arrangements for your pets.
- Turn off and unplug all appliances, lock doors and windows and (if you've been instructed to do so) turn off all utilities at the main switches or valves.
- Take your Emergency Supply Kit and any important papers/documents with you.
- Leave a note in your mailbox saying where you've gone.
- Listen to emergency personnel and follow their directions. Follow specified routes. Don't take shortcuts as you may end up in a blocked or dangerous area.
- Register with the local emergency reception centre when you leave home, even if you are not staying at the centre; emergency responders need to know how to reach you to advise when it is safe to return.

EVACUATION OF SENIORS and/or DISABLED

Special consideration needs to be given to those with special needs.

Most **visually impaired** persons are familiar with the immediate area they are in. In an emergency situation, tell the person the nature of the emergency and guide them through any dangerous areas. Don't leave them alone until they are in a safe environment.

As a person with a **hearing impairment** may not have heard any emergency warnings, write out what is happening and tell them the evacuation procedure, such as: "There is a fire. Follow me to the rear door."

ALL-HAZARD

Emergency Preparedness Workbook

Section 3

IMPORTANT FAMILY AND INDIVIDUAL INFORMATION

When disaster strikes, you may need to access important contact numbers, health information and household documents. Keep copies in two secure locations. A safety deposit box, a fireproof safe or watertight bags in the freezer work very well. Stored items should include deeds, wills, tax records, birth certificates, health records and photographs or videotapes of valuables for documentation for insurance claims.

LEGAL and FINANCIAL INFORMATION

1. Name and Social Insurance Numbers of All Family Members

Name: _____ SIN _____

Name: _____ SIN _____

Name: _____ SIN _____

Name: _____ SIN _____

Name: _____ SIN _____

Name: _____ SIN _____

Name: _____ SIN _____

Name: _____ SIN _____

2. Bank Accounts

Bank: _____

Account Type: _____ Acct. # _____

Account Type: _____ Acct. # _____

Account Type: _____ Acct. # _____

Bank: _____

Account Type: _____ Acct. # _____

Account Type: _____ Acct. # _____

Account Type: _____ Acct. # _____

Bank: _____

Account Type: _____ Acct. # _____

Account Type: _____ Acct. # _____

Account Type: _____ Acct. # _____

3. Insurance Policies

Life Insurance Company: _____

Policy Type: _____

Life Insurance Company: _____

Policy Type: _____

House Insurance Company: _____

Policy Type: _____

Other Insurance: _____

Policy Type: _____

4. Vehicle Registration Numbers

Vehicle Make: _____

Licence # _____ ID # _____

Vehicle Make: _____

Licence # _____ ID # _____

Vehicle Make: _____

Licence # _____ ID # _____

Vehicle Make: _____

Licence # _____ ID # _____

EMERGENCY SUPPLY KIT INFORMATION

1. Names of Household Members (including boarders)

Name: _____ Name: _____
Name: _____ Name: _____
Name: _____ Name: _____
Name: _____ Name: _____

2. Employment Information

Father's Work Phone Number: _____

Name of Employer: _____

Employment Address: _____

Mother's Work Phone Number: _____

Name of Employer: _____

Employment Address: _____

Person Responsible for Children: _____

Work Phone Number: _____

Home Number: _____

3. School Information

Child's Name: _____

School Name: _____

School Address: _____

Phone Number: _____

School Policy is to Hold Release child in an emergency.

Child's Name: _____

School Name: _____

School Address: _____

Phone Number: _____

School Policy is to Hold Release child in an emergency.

Child's Name: _____

School Name: _____

School Address: _____

Phone Number: _____

School Policy is to Hold Release child in an emergency.

4. Medical Contacts

Doctor's Name: _____

Clinic Address: _____

Phone Number: _____

Doctor's Name: _____

Clinic Address: _____

Phone Number: _____

Dentist's Name: _____

Clinic Address: _____

Phone Number: _____

Home Care Provider: _____

Address: _____

Phone Number: _____

5. Personal Medical Information (include prescriptions for drugs & glasses)

Name: _____

Allergies: _____

Medications: _____

Eye glass prescription: _____

Special Needs or Limitations: _____

Name: _____

Allergies: _____

Medications: _____

Eye glass prescription: _____

Special Needs or Limitations: _____

Name: _____

Allergies: _____

Medications: _____

Eye glass prescription: _____

Special Needs or Limitations: _____

Name: _____

Allergies: _____

Medications: _____

Eye glass prescription: _____

Special Needs or Limitations: _____

ALL-HAZARD

Emergency Preparedness Workbook

Section 4

EMERGENCY SUPPLY KITS

A properly prepared and maintained Emergency Supply Kit can be the key to bringing you and your family through a major disaster. The **kit should contain everything your family may need to be self sufficient for at least 72 hours**. Plan your kit carefully; every family is unique and has personal preferences, allergies and needs to recognize.

Emergency supplies can be acquired as ready-made kits or assembled item by item, as they are listed in this workbook. You can lessen the initial cost by purchasing any missing supplies over several paydays.

Store your Emergency Supply Kit in a cool shaded place away from chemicals and not directly on a concrete floor. A plastic or metal container with a tight fitting lid will protect contents from odours, moisture damage and rodents. If you choose to use a duffel bag or backpack, wrap a large garbage bag around it for extra protection.

Keep your kit accessible. Possible locations are a closet near an exit or in your camper or an outside shed.

You may want to consider storing supplies in individual packs within your big container so kit supplies are easier to move when evacuating.

Go through your kit every six months. Spring and fall are a good choice as you can rotate your seasonal supplies to suit the oncoming weather conditions. Ensure all batteries are working and replace water supplies and any items with a shelf life. When the update is complete, mark the next date on a prominently placed calendar.

HOME EMERGENCY KIT

FOOD SUPPLIES

When assembling your emergency food supplies, choose foods that:

- don't require refrigeration
- need little or no preparation
- are familiar to your family
- will not increase thirst
- require little or no water

Don't forget to include any special dietary needs and a few treats, such as your family's favourite cookies or chocolate bars.

Check your local sporting goods and army surplus stores for pre-packaged kits. Keep the volume small and light and easy to carry in case an evacuation is necessary. Choose items such as: peanut butter, canned fruits, vegetables and stews, canned fish and meat, pasta, beans and beef jerky. High nutrient food bars, nutritional drinks and dried nuts and fruit are also good. Seal all foods to prevent contamination by rodents, insects, humidity, ground water and drastic variations in temperature.

A three-day supply is the minimum amount of food for your Emergency Supply Kit but, as a major disaster can disrupt your ability to purchase food, it is wise to **maintain a two-week supply** in your everyday household provisions.

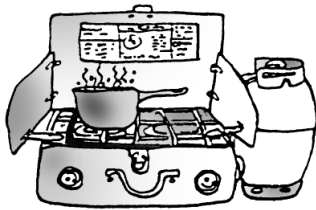

Camp stoves, sterno stoves, barbecues and hibachis can be used as alternate cooking sources but **do not use these inside your home!** This could cause carbon monoxide poisoning or a fire if there is an undetected gas leak. A fondue pot or fireplace are other possibilities. If using the fireplace, be sure to inspect the chimney, mortar and flue for cracks before use.

Infant Needs

Based on your infant's special diet and requirements, you should be prepared for a survival period of three to five days. Check with a pediatrician or family doctor to be certain your pack contains the proper supply of nourishment.

Food Related Supplies

- salt (in sealed container)
- heavy duty aluminum foil
- plastic wrap
- small container of dish soap
- sealed containers for storage
- plastic bags (assorted sizes) with twist ties
- cooking pot, paper plates, cups & utensils
- large garbage bags (a bright colour can also be used as a signal flag)
- cooking fuel (propane, charcoal, sterno, etc.)
- bottle opener
- good quality manual can opener
- cooking utensils
- washing pan
- alternate cooking source



If using china or plastic dishes, limit dishwashing by lining dinnerware with plastic food wrap to throw away after each use. You can also label separate drinking cups for each family member to use throughout the day.

WATER PROVISIONS

Water is the most important item to store. You will need at least four litres (1 gal.) of water per person per day (approximately two for drinking, two for food preparation and hygiene). Reduced intake of water can adversely affect your health and ability to survive. A family of four will need 48 litres of water to have a three-day supply on hand.

- Purchase bottled water if possible.
- If creating your own water supply, store water in sturdy, opaque plastic jugs. Avoid using plastic milk containers as the material becomes brittle over time and may crack.
- Clean the inside of the jugs thoroughly. Fill half the jug with water and add chlorine bleach in the amount listed below for purifying water. Finish filling the container to its top with water. Spread melted candle wax around the top of the rim and screw the lid on tightly to create an air tight seal. Date the bottle and label it "purified drinking water."

Store these containers in cool, dark locations. Avoid storing water in areas where toxins (such as gasoline and pesticides) are present as the vapours will penetrate the plastic over time. Do not store any plastic water container directly on concrete. The concrete will leach chemicals into the water causing contamination and it will also degrade the container itself.

Additional Sources of Water

Hot water heater: It is easier to drain water from the heater if a hot water faucet is turned on somewhere in the house. You must shut off the gas or electricity before emptying the heater and turn it on only after the water heater has been totally refilled.

Flush tank of the toilet: Purify this water before using it. However, if you use any commercial cleaning treatments in your tank, do not use this water for drinking.

Existing water in the plumbing: After shutting off the main water valve, open a faucet on the top floor and catch the water as it drains from an open faucet on the lowest level.

Do not use water from your jacuzzi, swimming pool or waterbed except for hygienic purposes. Chemicals in the water make it unsafe to drink.

Pipes that bring water into your home can be easily broken or cracked which might allow the water to become polluted. It is better to use your alternate water supply or to use the following purifying instructions:

Purification Techniques

Wash containers with soapy water then fill with a 10 per cent bleach solution. After five minutes, empty the container and let air dry. (The same bleach solution can be used to sterilize all the containers you are using.) Strain any sediment or particles from the water you are purifying by pouring it through several layers of paper towels, cheesecloth or coffee filters, then use one of the following purification methods:

- Boil the water for seven to 10 minutes.
- Add liquid household bleach* as follows:

Water	If Water is Clear	If Water is Cloudy
1 litre (1 qt.)	2 drops bleach	4 drops bleach
4 litres (1 gal.)	8 drops bleach	16 drops bleach
20 litres (21 qt.)	2.5 ml (½ teaspoon) bleach	5 ml (1 teaspoon) bleach

Directions: Shake the container of bleach and water to mix thoroughly then let water mixture stand for 30 minutes before using. There should be a faint chlorine scent after treating. If there isn't, add the same amount of bleach again and let it stand for another 15 minutes.

**Note: Use only household liquid bleach that contains 5.25 per cent sodium hypochlorite.*

Do not use scented bleaches, coloursafe bleaches or bleaches with added cleaners.

Do not use granular forms of bleach; they are poisonous.

Water purification tablets (available at drug stores) can also be used. Follow all package instructions carefully. If no drinking water is available, liquids may be obtained from canned fruits, vegetables and soft drinks.

FIRST AID SUPPLIES

First aid supplies can be purchased in ready-made units or you can assemble one yourself with fresh supplies. Store supplies in a small container with a handle, such as a cosmetic case or tackle box; this makes them easier to carry. Tape a list of contents inside the lid. Don't forget to check the expiration dates.

When purchasing prescription medications, ask your pharmacist about the storage requirements and the length of time that your meds can safely be stored. If possible, purchase an extra amount (two-week supply) for your First Aid Kit and rotate the supply whenever you refill the prescription.

Medicine

- | | |
|---|--|
| <input type="checkbox"/> Hydrogen peroxide to wash and disinfect wounds | <input type="checkbox"/> Prescription medications taken on a regular basis |
| <input type="checkbox"/> Cough mixture or lozenges | <input type="checkbox"/> Anti-diarrhea medicine |
| <input type="checkbox"/> Antibiotic ointment for dressings | <input type="checkbox"/> Vitamin supplements |
| <input type="checkbox"/> Laxatives | <input type="checkbox"/> Anti-nausea tablets |
| <input type="checkbox"/> Individually wrapped alcohol swabs | <input type="checkbox"/> Smelling salts |
| <input type="checkbox"/> Anti-inflammatory pills (e.g. Aspirin) | <input type="checkbox"/> Pain killers (e.g. Acetaminophen) |
| <input type="checkbox"/> Antacids | <input type="checkbox"/> Syrup ipecac (to induce vomiting) |

Medical Equipment

- | | |
|--|--|
| <input type="checkbox"/> Non-breakable thermometer | <input type="checkbox"/> Tweezers |
| <input type="checkbox"/> Eye wash cup and sterile water | <input type="checkbox"/> Safety razor blade |
| <input type="checkbox"/> Pocket knife (Swiss army style) | <input type="checkbox"/> Scissors (bandage & heavy duty) |
| <input type="checkbox"/> Needle and thread | <input type="checkbox"/> Safety pins (assorted sizes) |
| <input type="checkbox"/> Pack of disposable latex gloves | <input type="checkbox"/> Surgical masks |
| <input type="checkbox"/> Splint material | |

Bandages

Ask at your supply store for the correct amounts appropriate to the size of your family.

Note: If necessary, bandages can also be made from clean rags and sheets, disposable diapers and sanitary napkins. Dressings can be held in place by neckties, cloth belts, nylon stockings and plastic bags.

Following is a list of the various types of bandages to include in your kit:

- | | |
|---|---|
| <input type="checkbox"/> Adhesive bandages (assorted sizes) | <input type="checkbox"/> Adhesive dressings |
| <input type="checkbox"/> Elastic bandage (several widths) | <input type="checkbox"/> Large triangular bandages |
| <input type="checkbox"/> Sterile gauze pads | <input type="checkbox"/> Sterile dressings |
| <input type="checkbox"/> Abdominal pads | <input type="checkbox"/> Rolled gauze (several widths) |
| <input type="checkbox"/> Butterfly bandages | <input type="checkbox"/> Adhesive tape (several widths) |

ADDITIONAL SUPPLIES

- | | |
|--|--|
| <input type="checkbox"/> First aid book | <input type="checkbox"/> Writing materials and paper |
| <input type="checkbox"/> Cotton balls or swabs | <input type="checkbox"/> Pre-moistened towelettes |
| <input type="checkbox"/> Bar of soap | <input type="checkbox"/> Tissues |
| <input type="checkbox"/> Petroleum jelly | <input type="checkbox"/> Skin lotions |
| <input type="checkbox"/> Calamine and sunscreen lotion | <input type="checkbox"/> Insect repellent |
| <input type="checkbox"/> Instant cold and heat packs | <input type="checkbox"/> Hot water bottle |
| <input type="checkbox"/> Waterproof matches | <input type="checkbox"/> Contact lenses and supplies |
| <input type="checkbox"/> Extra eyeglasses | <input type="checkbox"/> Paper cups |
| <input type="checkbox"/> Plastic bags | <input type="checkbox"/> Plastic spoons |
| <input type="checkbox"/> Small spray bottle for 10% bleach solution for disinfecting | |

Clothing

Plan your clothing to suit all the seasonal weather conditions that occur in your area. In extremely cold conditions, warmth is found in wearing multiple layers of clothing to reduce or restrict body heat loss. For summer, you'll need protection against the sun.

Your body's greatest heat loss occurs around your head and neck; include hats and scarves for winter as well as sun hats and glasses for summer. Shoes and boots should be warm, strong and waterproof. Include heavy wool socks, good quality rain gear and heavy work gloves or mitts with liners. Coats and jackets should also match the weather conditions.

Lighting

Store two or three alternate sources of lights. **Caution:** make sure there are no gas leaks before using any open flame, including matches, candles and lanterns. Remember that in an earthquake situation, aftershocks may cause these to topple, which could start a fire, so locate them with care.

- Flashlights, extra batteries and spare bulbs – batteries stored in the refrigerator last longer. Keep a small flashlight in your car, purse and briefcase. No matter where you live, you will have a source of light.

- Camping lanterns – include extra fuel, wicks, mantles and waterproof matches.
- Lightsticks – these can provide light for one to 12 hours and can be purchased at camping supply stores.
- Candles – placing these in glass jars taller than the candle provides extra protection if the candle is knocked over. Remember that the glass can become very hot.



Other Necessary Items

- | | |
|---|---|
| <input type="checkbox"/> Infant supplies (diapers, bottles, formula, etc.) | <input type="checkbox"/> Hard hats and eye protectors |
| <input type="checkbox"/> Mylar blankets (also known as rescue, space or foil blankets) | <input type="checkbox"/> Money (including coins) |
| <input type="checkbox"/> Sleeping bags and pillows | <input type="checkbox"/> Signal flares and flag |
| <input type="checkbox"/> Hand towels and wash cloths | <input type="checkbox"/> Personal address book |
| <input type="checkbox"/> Paper towels | <input type="checkbox"/> Reading materials and games |
| <input type="checkbox"/> Tooth brush and tooth paste | <input type="checkbox"/> Safety rope and shovel |
| <input type="checkbox"/> Hand soap and sterile towelettes | <input type="checkbox"/> Nails, hammer, axe |
| <input type="checkbox"/> Feminine hygiene supplies | <input type="checkbox"/> Pliers, screwdriver |
| <input type="checkbox"/> Waterproof, intrinsically-safe (sparkless) flashlight and spare bulb | <input type="checkbox"/> Whistle |
| <input type="checkbox"/> AM/FM portable radio (wind-up or battery operated) | <input type="checkbox"/> Emergency survival book |
| <input type="checkbox"/> Good quality spare batteries | <input type="checkbox"/> OK/HELP sign (contact your local emergency coordinator or the Provincial Emergency Program for a sign, or visit PEP's Web site to download a copy:
www.pep.bc.ca/hazard_preparedness/HELP-OK_sign.pdf) |
| <input type="checkbox"/> Disposable dust masks | <input type="checkbox"/> Tent and related supplies or a waterproof tarp |

PET EMERGENCY KIT

- | | |
|--|--|
| <input type="checkbox"/> Portable kennel or cage (which can be used to store all pet supplies) | |
| <input type="checkbox"/> Food (two week supply – if canned, include a manual can opener) | |
| <input type="checkbox"/> Water (two week supply of water – 30 ml per kg of pet weight per day) | |
| <input type="checkbox"/> Food and water dishes | <input type="checkbox"/> Collar, chain, leash or harness |
| <input type="checkbox"/> Pet toys and treats | <input type="checkbox"/> Extra identification tags |
| <input type="checkbox"/> Pet health and vaccination records | <input type="checkbox"/> Blanket |
| <input type="checkbox"/> Plastic bags to collect and dispose of wastes | |

VEHICLE EMERGENCY KIT

Because disasters can happen at any time and anywhere, you may not be able to return home immediately so it is important to be prepared and to make your car as comfortable as possible. Include enough supplies to sustain you for at least 72 hours in case the roads are severely blocked or bridges are destroyed. Keep your gas tank at least half full at all times, especially in winter.

The following list can be assembled or purchased as a comfort kit for your car. Plan to rotate your food and water in the spring and fall: during the winter you would use foodstuffs that are not damaged by freezing and in the summer, foods that wouldn't be damaged by heat.

PERSONAL SUPPLIES

- | | |
|--|--|
| <input type="checkbox"/> Sturdy backpack (for storing supplies) | <input type="checkbox"/> Matches and survival candles |
| <input type="checkbox"/> Essential personal medication | <input type="checkbox"/> Warning lights and flares |
| <input type="checkbox"/> Coins and phone credit cards | <input type="checkbox"/> Light sticks |
| <input type="checkbox"/> Out-of-area contact card | <input type="checkbox"/> Dust masks and hard hat |
| <input type="checkbox"/> Personal address book | <input type="checkbox"/> Extra clothing |
| <input type="checkbox"/> Bottled water (3-day supply) | <input type="checkbox"/> Sturdy walking shoes |
| <input type="checkbox"/> Non-perishable food
(granola, beef jerky, nuts, dried fruit) | <input type="checkbox"/> Socks and heavy gloves |
| <input type="checkbox"/> Large ziplock bags | <input type="checkbox"/> Rescue blanket or sleeping bag |
| <input type="checkbox"/> Toilet tissue and newspaper | <input type="checkbox"/> Local maps and a compass
(know how to use them properly) |
| <input type="checkbox"/> Tooth brush and paste | <input type="checkbox"/> Utility knife |
| <input type="checkbox"/> Feminine hygiene supplies | <input type="checkbox"/> Axe/hatchet |
| <input type="checkbox"/> Thick hand towel | <input type="checkbox"/> Tube tent |
| <input type="checkbox"/> Whistle (3 short blasts is help signal) | <input type="checkbox"/> Picture of loved ones |
| <input type="checkbox"/> Flashlight | <input type="checkbox"/> Light reading material and/or deck of cards |
| <input type="checkbox"/> AM/FM radio | <input type="checkbox"/> Small first aid kit |
| <input type="checkbox"/> Extra alkaline batteries and bulb | |

VEHICLE SUPPLIES

- | | |
|---|--|
| <input type="checkbox"/> Fire extinguisher | <input type="checkbox"/> Tools |
| <input type="checkbox"/> Rags and/or paper towels | <input type="checkbox"/> Shovel and booster cables |
| <input type="checkbox"/> Tow chain or rope | <input type="checkbox"/> Sand, salt, kitty litter or traction mats |
| <input type="checkbox"/> Ice scraper and brush | <input type="checkbox"/> Methyl hydrate to de-ice fuel line and windshield |

WORKPLACE EMERGENCY KIT

Safety at work will help ensure a safe return home to your family. Be prepared to turn your workplace into a temporary shelter; don't presume your employer has this responsibility. The following items will fit into a standard athletic bag or backpack and will make the separation from your loved ones more bearable:



- Small first aid kit
- Essential personal medication
- Out-of-area contact card
- Personal address book
- Cash, including coins
- Phone credit cards
- Bottled water (3-day supply)
- Non-perishable foods: (granola, beef jerky, nuts, dried fruit)
- Large ziplock bags
- Toilet tissue and newspaper
- Personal toiletries
- Sterile towelettes
- Feminine hygiene supplies
- Picture of loved ones
- Survival blanket and extra clothing
- Sturdy walking shoes, socks
- Heavy gloves and hat
- Whistle (3 short blasts for help)
- Flashlight, intrinsically-safe (sparkless)
- AM/FM radio
- Extra alkaline batteries and bulb
- Waterproof matches and emergency candles
- Dust masks and hard hat
- Lightweight reading material or deck of cards

Section 5

SANITATION

In a disaster situation, the usual methods of removing garbage, refuse and human waste may be unavailable. Improper disposal of these wastes however, can lead to secondary problems such as the spread of disease. Use these guidelines to help protect your family and community.

DISPOSING OF HUMAN WASTES

Solid wastes (feces) create a health problem that must be dealt with carefully. The following are recommended ways to approach this:

- If damage exists only in the water lines you can still use the toilet. Turn off the main water valve and use water from a swimming pool, jacuzzi or other available source (don't waste drinking water). Pour water directly into the bowl; this will flush the waste down.
- If damage is suspected in the sewer lines however, do not flush the toilets. Remove the water from the toilet bowl and line it with two sturdy plastic bags. Fold the bags down over the sides and put absorbent material such as kitty litter or shredded newspaper into the inner bag. Defecate directly into the inner bag. Use toilet paper sparingly and put used tissues into the same bag. Sprinkle disinfectant directly onto the feces. (Do not use dry bleach as it is caustic; powdered hydrated lime is recommended and it can be purchased at hardware, home and garden centres). Replace the cover and wash your hands.
- Use a separate bucket for containing urine; a bucket that can be tightly covered, putting used toilet paper into the emergency toilet.
- Always keep the lid down on the toilet when not in use.

A sturdy bucket with tight fitting lid, small trash can or portable toilet will serve as an alternative to your toilet. Line containers with a durable plastic bag and follow the above instructions. Be sure to keep used waste bags in a container well away from human activity and labeled "Human Waste" and follow instructions from emergency personnel for disposal. The urine bucket can be emptied in an area that is not near a well, spring or other water supply, nor subject to flooding. It should be poured into a hole 45-60 centimetres (18-24 inches) deep and the hole should be filled in afterwards with dirt.

HANDLING GARBAGE

Odour, insects and vermin are problems that occur when garbage cannot be disposed of. Be sure to strain any left over liquids and bury the residue in the same way as urine. After straining, wrap solids in layers of newspaper and store in plastic garbage bags in a large garbage can with a tight-fitting lid. Keep in an area away from human activity and keep your pets and other animals from getting into the container.

Important Note:

Wash your hands with soap and water after handling human waste and garbage.

Section 6

HAZARDS/EMERGENCY PREPAREDNESS

EARTHQUAKES

The danger of an earthquake is a concern to many British Columbians. Every year British Columbia is subject to over 800 earthquakes – 200 of which occur on Vancouver Island and the Lower Mainland. With over 70 per cent of our population living in the southwest corner of the province, that concern is well founded. If we take the time to prepare ourselves, though, the possibility of injury and property damage will be considerably reduced.

It might help to first look at what an earthquake is and what to expect when it occurs:

The earth's surface is made up of huge plates of rock that gradually move over, under and past each other. Over time, accumulated stress causes the rock to suddenly break or slip along a fault. This sudden movement and release of energy causes the ground to shake, pitch, and roll as seismic waves move through the earth.

As you might expect, this sudden, rapid shaking can collapse buildings, bridges, tunnels; disrupt utility services (phone, water, sewer, gas); and trigger landslides, fires, and floods. As frightening as this sounds, it has been proven that when a community is prepared, the impact of an earthquake can be drastically reduced.

BEFORE AN EARTHQUAKE

- Identify safe places in each room of your house
- Identify the danger zones, such as by windows, swinging doors, tall or hanging objects, chimneys or near gas appliances
- Practice your Family Emergency Plan
- Consider purchasing earthquake insurance to defray costs of any damage
- Use the Home Hazard Hunt checklist to help prepare your home (*see next page*)
- Review earthquake procedures at your workplace
- Discuss the earthquake plan at your children's school

HOME HAZARD HUNT

Preparing your home for dangerous situations such as earthquakes is well worth your time and financial investment and could prevent injury to your family. This doesn't have to be a restrictive process; be creative. For example, if you're in an earthquake zone and need to remove heavy pictures from above your bed or couch, replace them with "soft art," such as tapestries.

The ground movement that accompanies earthquakes is seldom the cause of property damage. Homes that are structurally sound with their internal contents properly secured, generally come through earthquakes with relatively little damage. On the other hand, unprepared homes are unsafe and their contents will be vulnerable to the shaking motion of an earthquake.

Using this list as your guide, walk through your home and identify the hazards that exist in each room. Address each hazard by following the instructions listed on the pages associated with them. Check off the item as you complete making any necessary changes.

A quick rule of thumb: "If it's taller than it is wide, secure it!"

- Start with your **water heater**. There should be very little space between the water heater tank and the wall. If there is more than 30–50 millimetres (one to two in.), attach a wooden block (for example, 2 x 4) to the wall studs with long screws. The goal is to create a snug fit between the tank and the wall studs with long screws. Wrap heavy-gauge metal bands or nylon strapping $1\frac{1}{2}$ times around the tank and fasten to the wooden block between the wall and the water heater.

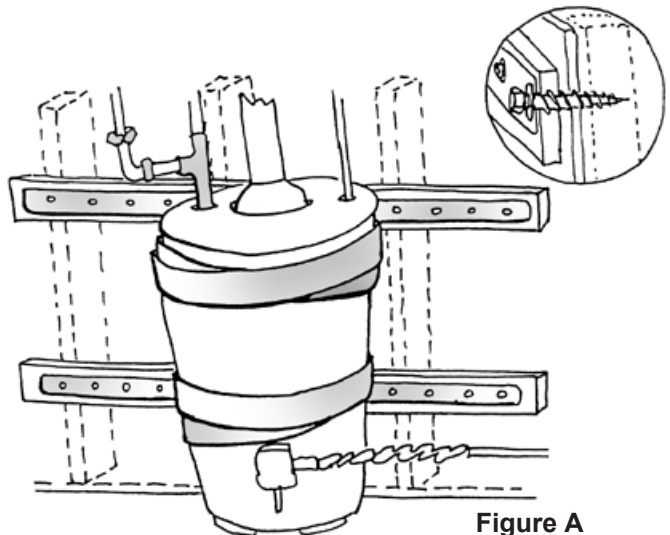

Figure A

- Secure any gas appliances such as your stove or clothes dryer to a wall stud. If these objects move or topple, the resulting gas leak could destroy your home. Use flexible gas lines (where the gas code permits) to allow for a small amount of movement.
- Secure refrigerators, top and bottom, with plumbers tape (perforated metal strapping). Screw one end into a wall stud and fasten the other securely to a structural component of the refrigerator but NOT the coils. Coils are made of lightweight material and will not support the weight of the unit.

- Wood burning stoves are usually freestanding so they are unsupported and vulnerable to sliding or overturning. Check with the manufacturer about bolting your particular model to the floor.
- If you must use castors or glides on appliances, lock the wheels or place a wedge under the front wheels to keep them from sliding or overturning.
- Top heavy and free-standing furniture such as tall bookcases, china cabinets, high chests of drawers and shelving units should be secured. Use braided metal cable, chain or angle brackets such as those in the diagram, to secure them to the wall anchor. Always screw wall anchors into a stud and don't use nails as they can pull out during a large earthquake. Reposition your beds so tall furniture won't fall directly on you.

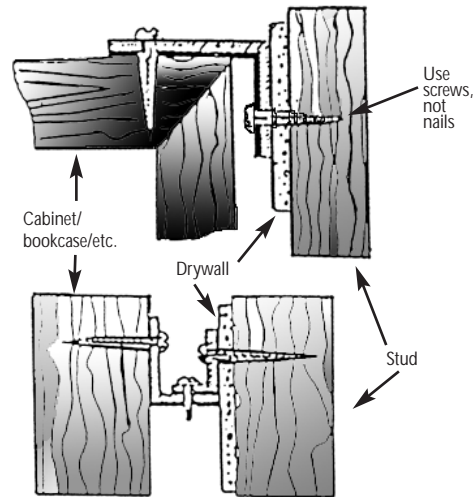

Figure B

Identify rooms and items that need securing as shown in Figure B:

Room _____	Item _____
Room _____	Item _____
Room _____	Item _____
Room _____	Item _____
Room _____	Item _____
Room _____	Item _____
Room _____	Item _____

- Heavy or breakable objects** on high shelves or in bookcases, cabinets or drawer tops are also dangerous. Move them to lower locations or attach a wooden or metal guardrail to open shelves to keep items from sliding off.

Room _____	Item _____
Room _____	Item _____
Room _____	Item _____
Room _____	Item _____
Room _____	Item _____
Room _____	Item _____
Room _____	Item _____

- Identify all **electronic equipment, small appliances and other items** that may slide off their counter or cabinet tops. For example, computers, stereos, microwaves, toasters, answering machines, sewing machines and lamps. Secure them with velcro, or for more delicate items, use dental wax or double-sided tape.

Room _____	Item _____
Room _____	Item _____
Room _____	Item _____
Room _____	Item _____
Room _____	Item _____
Room _____	Item _____
Room _____	Item _____
Room _____	Item _____
Room _____	Item _____
Room _____	Item _____

- Identify all your **hanging plants and lamps**, carefully check the location of all hanging plants and other objects. Determine if they are close enough to windows to strike them in the wild motion of an earthquake, if they are, consider moving them. Secure these objects by closing the opening in their hook with lock wire. Make sure the hook is directly screwed into a ceiling stud.

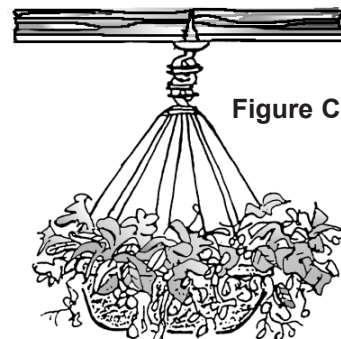

Figure C

Room _____	Item _____
Room _____	Item _____
Room _____	Item _____
Room _____	Item _____
Room _____	Item _____
Room _____	Item _____

- Mirrors and heavily-framed pictures.** If they are above a bed or couch, or beside an exit, move them to another place. As shown in Figure D on next page, one way to mount framed pictures and mirrors securely is to use long-shanked, open eye-hooks instead of traditional picture hangers. The eye-hooks must be long enough to penetrate the wall stud as well as the drywall or plaster. Eye-hooks used in this way

are much less likely to pull out of the wall than picture hooks installed with nails that penetrate only the drywall or plaster. Also, an alternative to running wire across the back of the picture or mirror is to use closed eye-hooks securely screwed into the back of the frame.

Note: Sliding mirror doors on closets already come with a protective backing that will keep the glass from spraying out if broken.

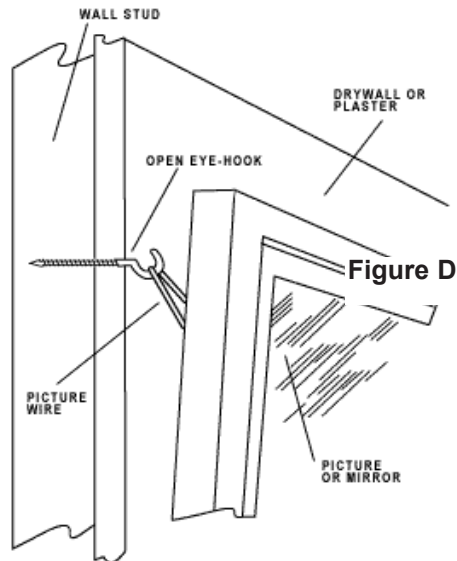

Room _____ Item _____

Room _____ Item _____

Room _____ Item _____

Room _____ Item _____

Room _____ Item _____

Room _____ Item _____

Room _____ Item _____

Room _____ Item _____

- Identify **latches** on kitchen, bathroom and workroom cabinets that will not hold in heavy shaking. Put heavy items on bottom shelves. To prevent cabinet doors from flying open, install a latch operated by a pull back mechanism or turn handle; or a latch like the example in Figure E.

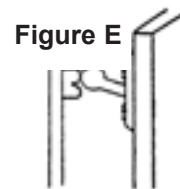

Room _____ Item _____

Room _____ Item _____

Room _____ Item _____

Room _____ Item _____

Room _____ Item _____

Room _____ Item _____

Room _____ Item _____

- Identify poisons, toxins and solvents** that are located in high or dangerous locations. Move them to lower areas behind a guardrail, or preferably, within a locked cabinet. Keep them away from your water and food storage areas and out of the reach of children and pets. If possible, store all flammable liquids in an outside building, away from structures and vehicles. (Spilled flammable liquids could easily cause a fire and destroy your home.)

Room _____ Item _____

Room _____ Item _____

Room _____ Item _____

Room _____ Item _____

Room _____ Item _____

- Window glass** will shatter and may be thrown across a room. Check into using safety glass and keep beds away from windows.

Room _____ Window _____

Room _____ Window _____

Room _____ Window _____

Room _____ Window _____

Room _____ Window _____

Room _____ Window _____

Room _____ Window _____

Room _____ Window _____

Room _____ Window _____

- Inspect the foundation of your home. Check house and garage for foundation bolts. These bolts secure the wood structure to the concrete foundation. They are placed approximately 1.8 metres (six ft.) apart along the sill plate and should look like the one illustrated (Figure F). Using a hammer drill and a carbide bit drill a hole through the sill plate into the foundation. Place these holes every six feet. Drop one 5 centimetre by 20 centimetre (2 x 8 in.) expansion bolt into the holes and finish by tightening the nut and the washer.

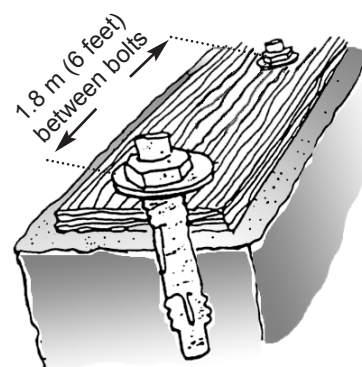

Figure F

Inspect the vertical studs that extend from the foundation to the first floor of your home. These are the **cripple walls**. If they are exposed on the inside, they could buckle in the severe ground motion that accompanies many large earthquakes. Strengthen the cripple walls by nailing plywood sheeting to the vertical studs. Also, inspect the garage for exposed cripple walls. This is important if the garage is supporting living quarters.

Bolted to the foundation?

Exposed cripple walls?

Post and Beams need to be inspected. For a building to stay together in an earthquake, all its parts must be fastened together. Metal connectors are used to strengthen places where the posts and beams of the walls and the floor and the ceiling join. To strengthen the connections between ceilings, walls and floors follow the directions in the diagram:

Don't forget to also examine all exposed framing in garages, basements, porches and patio covers.

Inspect your **chimney and roof** for loose bricks and tiles that may be jarred loose in an earthquake. Determine whether plywood should be added to the attic to protect your home in case your chimney falls. The provincial code requires that the clearance between interior chimneys and framing should be at least 50 millimetres (2 in.) or 12 millimetres (1/2 in.) for exterior chimneys. Reinforce the ceiling surrounding the chimney with two centimetre (3/4 in.) plywood nailed to the beams. This will provide protection from falling bricks that might break through the roof.

Chimney needs work?

Attic needs work?

Roof needs work?

Figure G

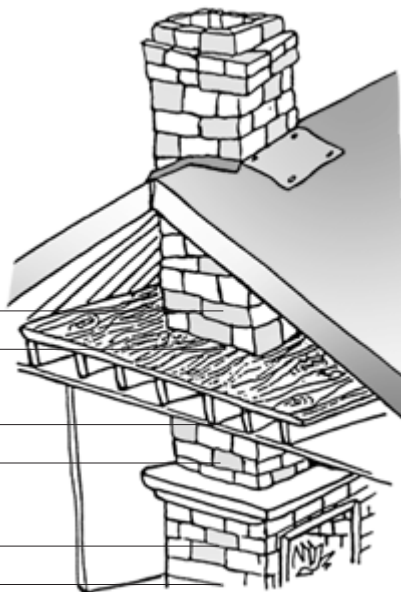
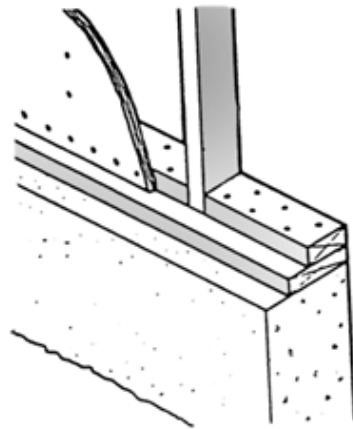
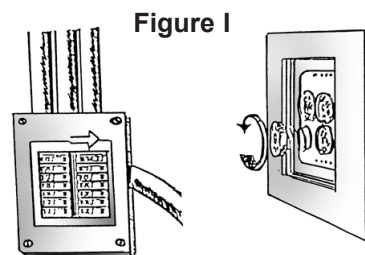

Figure H

- Be sure all household members know where the utilities are located and how to properly shut them off. Locate the electricity circuit box, it may look like one of these. Learn how to shut off the electricity to the entire house.



- When it comes to the water supply locate the shut off valve for the water main that enters the house. It may like this.

Valves that have not been turned may be rusted open or they may only partially close. Replace valve, if necessary. Label this valve with a large tag and make sure all family members know where it is located.

Figure J



- Natural gas leaks and explosions are responsible for a significant number of fires following any major earthquake. It is vital that you and all family members know where the gas meter is located and that everyone knows the proper procedures for turning it off.

Only shut off the gas at the meter if you smell the characteristic warning odour of gas and/or you notice a large consumption of gas being registered on the gas meter. Until you are sure no gas leaks exist, do not use matches, lighters, open flame, appliances or operate any electrical switches.

If you smell natural gas, immediately get everyone out of and away from the house. Open the windows and doors to provide ventilation.

EMERGENCY GAS SHUT OFF

Be prepared! Keep a 12" adjustable wrench handy and know the location of your gas meter.

Locate the gas meter and the shut-off valve on the inlet pipe, see the illustration. Make sure the valve will turn. It only takes a ¼ turn in either direction to shut gas main picture it off. Valves that have not been turned in a number of years may not easily move. Moving it about 1/8 of a turn is all that is needed to assure you that it can turn. Never try to turn the gas back on by yourself, even if you accidentally turn it off while practicing. You must call a qualified gas representative to come and turn it on for you. Turning it on yourself may create a problem with your natural gas equipment. Store a wrench where it can be easily attained in an emergency. Ensure all household members know where it is and how to use it.

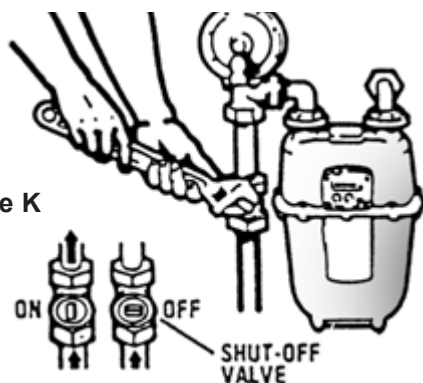

Figure K

Meters, valves, breakers have all been located, checked and household members are aware of procedures?

- Natural gas meter? Main circuit breakers? Main water valve?

DURING AN EARTHQUAKE

In an earthquake, sound usually precedes any ground movement by a split second. This is followed by shaking that can last from several seconds to several minutes. Over the following hours or days, aftershocks may occur.

In Your Home, Workplace or Other Building

Do not run for the exits and outdoors. Stay inside during the quake. **Duck, cover and hold.** Take cover beneath sturdy furniture or at an inside supporting wall or archway. Stay away from glass windows and heavy mirrors. Wait for 60 seconds after the shaking has stopped before you move from your position. Don't ignite candles, matches or lighters. Remain clear of falling debris.

The following are a few examples of how to adapt the above to suit your location:

In a High-Rise Building

Duck, cover and hold as in any other building. Wait for 60 seconds after the shaking has stopped before you move. Do not rush for the exits and do not use the elevator if you are leaving the building. Do not panic.

In Shopping Malls and Other Public Places

Try to take cover where you won't be trampled, avoiding windows, skylights and display shelves with heavy objects. Do not run for the exits or use the elevator. Seek assistance from staff to evacuate the building.

Outdoors

Take cover under anything sturdy such as a picnic table or bus bench and hold on until the shaking stops. Stay clear of tall buildings, brick walls, street lamps, overhead signs, hydro lines or other objects that may fall on you. If possible, duck into a doorway to avoid falling bricks, glass and other debris. If you're at the bottom of a hill, watch for landslides or falling boulders.

Never assume downed power lines are dead. People, metal and damp objects are conductors. Stay back to avoid electric shock.

In a Vehicle

Stay in the vehicle with your seatbelt fastened, until all shaking stops. The vehicle's hard-topped roof can protect you from falling debris. If a power line falls on the car, **DO NOT** get out, unless absolutely necessary. See page 46, Fallen Power Lines, for additional information. If you leave your vehicle after the quake, put a note in the window giving your name, condition and where you have gone.

On a Bus or Train

Stay in your seat until the bus or train has stopped and protect your head with whatever is available, such as a book or pillow. Follow the instructions of the driver and remain calm.

On a Boat or Ferry

Listen to the crew for direction. Being on the water, as being in an airplane, is safer than being on land during an earthquake.

Seniors and/or Disabled

If you are able, move to a safe place in the room that you are in. If you are unable to move quickly and safely, stay where you are and cover your head with pillows, blankets or magazines; anything to protect your head and face. If in a wheelchair, move to an archway or interior wall, if they are close. Be sure to lock the wheels and cover you head and neck with your hands.

AFTER AN EARTHQUAKE

- Don't try to go home right after a major earthquake. Stay where you are until it is safe to leave and then go to your reunion site.
- If you're in a coastal area and experience a large earthquake with shaking that lasts a minute or more, move immediately to higher ground as a tsunami may be approaching. Check the map on page 34, Preparing for a Tsunami, to see what areas of the province are in a tsunami zone.
- Check the building for damage, gas leaks and fires.
- Be prepared to help others.
- Hang up all phones that have been shaken off the hook and stay off your phone, cell phone and the Internet unless there is a life at stake.
- Listen to the radio or local TV station for more information and follow all instructions.

TSUNAMIS

Tsunami is a Japanese word meaning harbour wave. These huge waves are caused during an earthquake when plates along the ocean floor push up against each other. This will generate a series of ocean waves that race outward in all directions. A typical wave height for pacific tsunamis is between six to nine metres at the shoreline.

Tsunamis act quite differently from tidal waves and have nothing to do with tides or the weather. Although they move through the open ocean at intense speeds, they are scarcely noticeable, even when passing under a boat. Their danger lies in the shallower

water near shore where the height of the waves increases as the tsunami runs into river and coastal channels.

In British Columbia, there is a Tsunami Warning and Alerting Plan in place so as to warn coastal residents. However, if you live in a tsunami zone and feel a large earthquake, go inland or to higher ground immediately.

PREPARING FOR A TSUNAMI

Apart from the general preparedness rules, use the following as a guide for tsunamis:

- Know the areas of the province that are at risk. The shading on the outline map to the right indicates those coastal areas that could experience a damaging tsunami generated in conjunction with either a close or distant coast
- If you live in a tsunami zone know the local evacuation routes to safe areas on higher ground.
- Check with your community's local emergency coordinator to determine how they warn of an impending tsunami (phone, door-to-door, or siren).

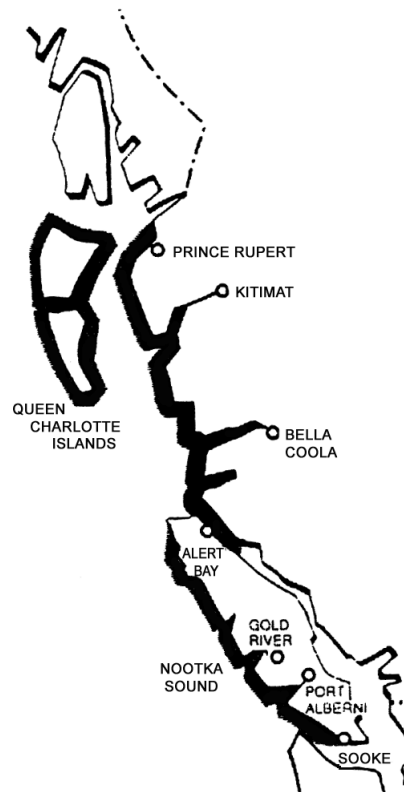

DURING A TSUNAMI

- If you're on a boat, leave the harbour for open water.
- If you're in a floatplane in a harbour, take off for a lake or land that is beyond the area of risk.
- If on land near the ocean, leave immediately. Go to ground that is at least 15 metres (49 ft.) above sea level. Waves should not exceed eight metres (26 ft.) but are often forced up to higher ground by the pressure of subsequent waves. It may be safer to proceed on foot if there's been a strong earthquake as roads and bridges could be damaged.
- Check for evacuation route signs but if the community is not posted, take a route that avoids tidal flats, the shores of coastal rivers and bay areas.
- Listen to the radio for instructions.
- Wait for the "all clear" signal.
- Never go to watch a tsunami. The waves are extremely dangerous and move faster than you can run.

FLOODS

Flooding can be caused by several events: heavy rains alone or mixed with spring's melting snow can create excessive run-off on rivers and lakes. Ice jams can also cause flooding when water upstream is blocked by ice downstream and on the coast, flooding can occur when seasonally high tides are amplified by a severe storm or tsunami. To prepare for flooding follow the steps below.

BEFORE A FLOOD

- Find out if you live in a flood zone and identify dams in your area.
- Know how to prepare for an evacuation.
- Keep important papers in watertight containers and have pictures or videos of your property and valuables.
- If there is a potential for flooding in your area, pay attention to radio and television for information and prepare your home and family.
- Watch for warning signs in your nearby environment: mudslides, debris in creeks, colour changes in water, trees leaning or cracks developing on hillsides.
- Consider purchasing flood insurance.

WHEN FLOODING OCCURS

If rising waters become a threat to your safety, obey all officials who are involved in rescue or flood control operations, including those directing traffic, as water can be deeper than it appears. It only takes 60 centimetres (2 ft.) to sweep a car away and as little as 15 centimetres (6 in.) of moving water can cause you to fall. Maintaining order will lessen the chance of personal injury to you and your loved ones.

If Outdoors

Climb to high ground and stay there. Avoid walking through any floodwaters.

In a Vehicle

Take extra care when driving. Familiar roads will appear drastically different when covered by floodwaters. Be on the lookout for damaged bridges, slides and washouts, and be particularly alert for downed power lines. If you come to a flooded area, choose an alternate route. If your car stalls, abandon it immediately and climb to higher ground.

In Your Home (*as much as time allows*)

- Be sure you know where your Emergency Supply Kit is.
- Follow your Family Emergency Plan.
- Ensure that each member of your family has warm clothing and waterproof footwear and outerwear.
- If a different meeting place than agreed on in your Emergency Plan is necessary because of the flooding, make sure every member of your household knows where the new location is. Provide the younger children with a note sealed in plastic stating the family's destination.
- Turn off power and unplug all appliances.

FLOOD THREAT PRECAUTIONS

To minimize flood damage to your personal property and the disruption of your day to day life, there are certain precautions that you may take. The following suggestions apply when there is immediate danger of flooding:

Electrical Service

Shut off power to premises. If the main switch is in an area that is already wet, stand on a dry board and use a dry stick to turn switch off. Do not attempt to turn off power if the room is already flooded.

Electrical Appliances

Disconnect all electrical appliances and, if possible, move them to a higher level. Thermally insulated appliances such as freezers, refrigerators and ranges should be given priority. Any appliances that cannot be moved should have motors, fans, pumps, etc. removed to higher levels.

Gas or Oil Furnaces and Appliances

Oil or water tanks will float if not full. Fill if possible, then plug vent holes. If unable to fill, weigh down with sandbags or wedge against a solid object. Propane gas tanks will float whether full or empty so turn off valve, disconnect tubing and plug the hole. Tie a chain or cable around the tank to anchor it and prevent it from floating away.

Plumbing Fixtures and Water Supplies

Turn off water supply. Plug all basement sewage connections, i.e. toilet, sinks showers, etc., with a wooden plug or other device. The plug should be held in place with a weight or wood brace to the joist above.

Other Precautions

Pesticides, weed killers, fertilizers and other articles that may cause pollution should be moved to higher levels. In order to relieve overloading of the sewer system, disconnect any downspouts draining to them. Move or remove all furniture and personal effects that could be damaged by flooding or which may float and cause damage.

Sandbagging

Construct the sandbag dike on high ground, close to your home or building. By being closer to your home or building fewer sandbags will be needed and the dike will be less exposed to any nearby streams. Dig a trench one bag in depth and two bags wide as a foundation for the dike structure. To be effective, a dike must be three times as wide at its base as it is high. The number of sandbags needed to protect a home or building varies depending on the local topography and the anticipated depth of water. A home on sloping ground that needs a sandbag dike on the frontage for about 2/3 of a metre of water, might need about 2,000 sandbags to protect it.

Bags Required for 30 metres of Dike:

Height Above Ground *(H)	Bags Required
1/3 metre	600 bags
2.3 metre	2,000 bags
1 metre	3,400 bags

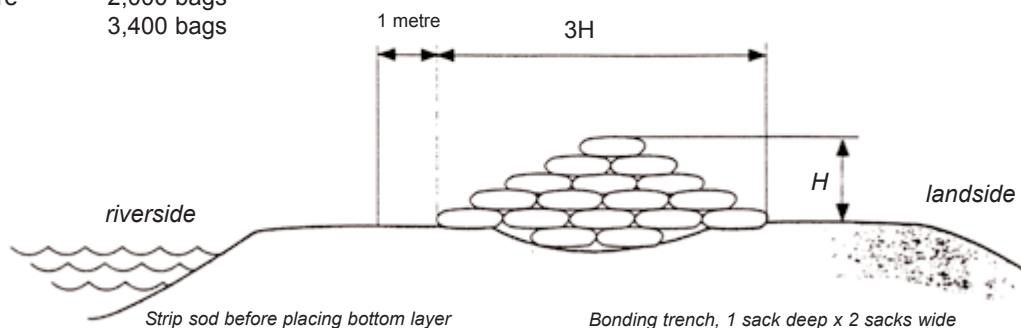
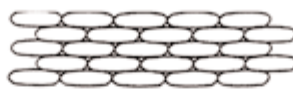

LANDSLIDES and/or AVALANCHES

LANDSLIDE

This down-slope movement of soil, rock and organic materials occurs frequently in B.C. To date, landslides account for more loss of life and property damage than other natural hazards such as earthquakes or flooding. Over the last 100 years, 27 catastrophic landslides have occurred. The Hope slide of 1965 was the largest of these; muddy debris moved down one side of the valley and then all the way up the opposite valley wall with enough material to fill a football stadium numerous times.

The Fraser Canyon and the Trans-Canada highway are two of several transportation routes, which are vulnerable to landslides. Highway workers use various techniques such as removing or bolting threatening rocks, attaching metal mesh or spraying concrete onto dangerous embankments. However, power transmission lines, gas pipelines and fiber optic cables are also vulnerable and if damaged can impact people throughout the province. Landslides, rockfalls and debris flows happen quickly and with little warning. If you are caught in one, use the following safety measures:

Indoors

Stay inside and take cover under a heavy table, desk or any solid furniture and hold on.

If Outside

Try to get out of the way by running to the nearest high ground in a direction away from the path of the landslide. If rocks and other debris are approaching, run for the nearest shelter such as a group of trees or a building.

If escape is impossible, curl into a tight ball and protect your head. When debris blocks a waterway, a flood can occur. Pay attention to radio and television and observe nearby water areas for signs of potential flood hazards.

AVALANCHE

Although an avalanche can occur in any season, winter is the riskiest time of year, especially following a fresh snowfall when the snow pack is settling and consolidating.

On the Coquihalla highway, there are over 100 avalanches a year and people can be left stranded or isolated for days. The force of an avalanche can kill anyone caught in its path, so be very careful when travelling in avalanche areas. Use the following safety rules as a guide:

- Check current weather forecasts and inquire about avalanche conditions.
- Dress appropriately.

- Obey all warning signs, do not stop in an avalanche area and do not go into areas that are out of bounds.
- Carry appropriate safety equipment, including items such as a whistle, small mirror and a brightly coloured garbage bag (which also protects against hypothermia).
- If injured or lost, stay where you are.

Take an avalanche awareness and rescue course if living near an avalanche area or venturing there for outdoor activities.

Recommended Equipment for Avalanche Areas

- Avalanche shovel (lightweight/collapsible/strong)
- Survival woodsaw
- Emergency probe
- Transceiver

PREPARING YOUR HOME/PROPERTY FOR A LANDSLIDE/AVALANCHE

- Learn about the local geology, specifically the area around your home site, to identify landslide risks. If your home is in a landslide area, determine whether you can limit damage by erecting retaining walls.
- If rockfalls are a danger, check with an engineer about drilling holes into the slope to encourage easy drainage of groundwater (reducing water pressure).
- Consider using lines of trees, specific forms of vegetation and steel netting to stabilize slopes.
- Use flexible pipe fittings for water and gas lines to lessen any damage.
- Avoid activities that result in the undercutting of steep banks.
- Before purchasing or subdividing land and before making construction applications, check with your municipal or district planner or building inspector.
- Don't build near the top or base of steep slopes, and don't place fill on them.
- If you live in an area where there is an avalanche risk, talk with your local authorities about controlled avalanche triggering. This is similar to methods used in ski/winter resort areas.

FOREST FIRES and INTERFACE FIRES

Fires cause extensive damage in our province every year. A lightning strike, a carelessly discarded cigarette or an abandoned campfire are a few of the ways a forest can be turned into flames. When the fire spreads into suburban or rural areas, it's called an interface fire and becomes a serious threat to your family and property. Remember; you cannot outrun a fire!

PROTECTING YOUR PROPERTY

- Keep your yard clear. Remove fallen needles, branches and long grass; anything that could cause a fire to spread to neighbouring trees.
- Prune low-level branches up to at least two and a half metres (8 ft.) above the ground. Replace bark mulch with gravel or decorative rocks.
- Move your woodpile, lawn furniture, tarp coverings and other combustible items away from your house or other buildings. Flammable materials should be at least 10 metres (33 ft.) away and uphill from your home and any propane or natural gas tanks.
- Ensure that there are at least three metres (10 ft.) between branches and power lines.
- If you live on a slope, pay particular attention to the downhill side of your property as fire can quickly race uphill and ignite trees, grass, buildings or anything flammable. Thin out down-slope trees to a greater distance from your house: the steeper the slope, the greater the distance.
- Use fire-safe building materials to give your home a rustic look without the danger of wood siding and shake roofs. You can purchase metal shingles that look like asphalt and cement siding products that look like wood. Non-combustible or fire-retardant materials should be used for your balcony and deck surfaces as well.
- Keep a hose and nozzle permanently connected and clearly visible. Make sure you have enough hose to reach your roof and all exterior walls. If water pressure is a concern, have a full barrel of water and a 10 litre (2 gal.) pail nearby.
- Keep a shovel or grubbing tool handy to prevent a ground fire from spreading.
- Be sure your roads and driveways allow easy access for emergency vehicles.
- Work together with your neighbours. Talk about a fire protection plan for your area and organize a neighbourhood work bee.

IN AN INTERFACE FIRE

Exercise the following precautions to protect your home until you're told to evacuate:

- Take down flammable drapes and curtains and close all venetian blinds or non-combustible window coverings.
- Be sure to turn off all pilot lights as well as the gas valves.
- Close all doors, including interior doors and windows to prevent a draft.
- Turn on one light in each room for visibility in heavy smoke.
- Place valuables that will not be damaged by water in a pool or pond.
- If hoses and adequate water are available, leave sprinklers on roofs and anything that might be damaged by a fire.

IF TRAPPED IN A FOREST FIRE

- Crouch in a pond or river and cover your head and upper body with wet clothing.
- If water is not around, look for shelter in a cleared area or among a bed of rocks. Lie flat and cover your body with wet clothing or soil. Breathe air close to the ground through a wet cloth to avoid scorching your lungs or inhaling smoke.

SEVERE STORMS

Generally speaking, staying indoors during a severe storm is your safest option and if you're outdoors, take shelter wherever you can find it. Learn the meanings of weather terminology and listen to the weather reports each day. Pay special attention to forecasts if you have to drive during poor weather conditions. If there is a severe storm warning, it is better not to travel until it is over. If caught outside in severe weather, use the following as a guide:

THUNDERSTORM

Take shelter in a building or depressed area such as a ditch or culvert. Don't go near trees, especially those standing alone. If swimming or in a boat, get to shore as quickly as possible.

HAILSTORM

Hail is precipitation consisting of ice pellets with a diameter of five millimetres or more and is formed in the core of thunderstorms. Some hailstones are the size of peas while others can be as big as grapefruits. Take cover in a building or under something solid when hail begins to fall. Do not go out to cover plants, cars or garden furniture or to rescue animals. Although no one in Canada has ever been killed by hail, people have been seriously injured by it.

LIGHTNING STORM

If you are in a building, stay inside away from windows, doors, fireplaces, radiators, stoves, metal pipes, sinks or anything else that could conduct an electrical charge. Unplug all TVs, radios, coffee pots and other electrical appliances. Don't use the phone or other electrical equipment.

If you are outside, seek shelter in a building, cave or any depressed area. If there is no shelter, crouch down with your feet close together and your head down. Don't lie flat; minimize your contact with the ground to reduce the risk of being electrocuted by a ground charge. Keep away from pay phones, power lines, fences, trees and hilltops. Get off bicycles, motorcycles and any other equipment such as tractors. If you are in a vehicle, pull over and stop away from trees or power lines and stay inside your vehicle.

SEVERE RAINSTORM

If outdoors, take shelter on higher ground in case of flash flooding. If in a vehicle, pull over and stay inside.

TORNADO

Large tornadoes are rare in British Columbia, but there have been several smaller ones sighted. Very few places in British Columbia appear to be completely free from risk. During a tornado take shelter in the basement or in a small, interior, ground floor room like a bathroom or closet. Crouch down (duck, cover and hold) as you would in an earthquake and avoid windows. If you live in a mobile home, take shelter elsewhere. If you are outdoors or travelling, take shelter in a ditch or culvert away from the car. Lie flat and protect your head from debris.

BLIZZARD OR SNOWSTORM

Take shelter wherever you can. Visibility can be virtually zero and you may easily lose your way. If you must travel during a blizzard or snowstorm, do so during the day and let someone know your route and expected arrival time.

If caught in a vehicle during a blizzard or snowstorm use the following as a guide:

- Pull off the highway and put your hazard lights on.
- Hang a distress flag from the radio antenna.
- Set out warning lights or flares.
- Switch on your dome light rather than the headlights.
- Run the engine and heater about 10 minutes each hour to keep warm. While the engine is running, open a window slightly and keep the exhaust pipe free of snow. Be careful not to run the vehicle battery down.
- Exercise your limbs, hands and feet to maintain body heat.

- Huddle with passengers to stay warm. Wear your hat (you lose 60 per cent of your body heat through your head).
- Take turns sleeping.
- If stranded in a remote rural or wilderness area, spread a large cloth over the snow to attract attention of rescue personnel or over the top of your car with the edges locked in the windows if it is windy.

PROTECTING YOUR PROPERTY AGAINST A SEVERE STORM

If you live in an area prone to severe storms there are things you can do to keep your home safe:

- Prune dead or rotting branches and cut down dead trees to reduce the danger of them falling on your house. Contact BC Hydro to have tree limbs removed around power lines.
- Keep the exterior of your house in good repair: roof tiles, the chimney and other masonry need to be in good shape and eaves troughs should be cleared of debris and connected to downspouts.
- Check the drainage around your house to reduce the risk of basement flooding after a heavy rain.
- Secure items that might be blown around or torn loose.
- Keep your car in the garage to protect against damage.

POWER OUTAGES

The main cause of power outages is accumulations of ice on power equipment or broken branches falling on power lines. But whether the outage is caused by a blown fuse, failure in the line equipment or a bad storm, the result is still the same.

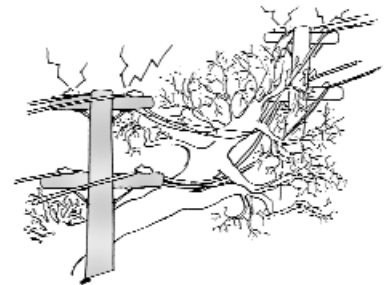

DURING A POWER OUTAGE

Knowing what to do during a power outage can lessen the impact on your home and community. Use the following as a guide:

- Look out your window to see if neighbouring homes have lights on. If they do, check your fuse box or circuit breaker panel to see if a switch has blown. If neighbourhood lights are all off however, listen to your portable radio for information. This may prevent you from having to call the power company and unnecessarily tying up the phone lines.

- From your home, scan the neighbourhood to look for trouble indicators, such as flashes of light and downed wires. Do not go to these areas; call the BC Hydro repair and outage number that is listed in the phone book.
- It's a good idea to throw the breaker on your large appliances, such as ranges and dryers but be sure they are already off **before** you throw the main household breaker switch or remove any fuses.
- Turn down thermostats and disconnect all electrical heaters and appliances to reduce the initial demand when the power is reconnected.
- Although spike suppressors (power surge bars) can provide full-time protection for sensitive electrical equipment they are not foolproof. If you have items such as a personal computer, microwave oven or VCR, unplug them to protect against possible surges when the power is restored.
- Keep doors, windows and drapes closed. Close off extra rooms so the heat will concentrate in one area.
- Conserve water in case electric pumps from wells or pumping stations are out of power. Water from the taps for drinking should be okay as there will be some water left in your hot water tank.
- Turn off all lights except one, which will alert you when the power has been restored.
- Keep the doors of your refrigerator and freezer shut as much as possible to maintain the cold temperature.
- If the power is to be off for a lengthy period of time and you don't have an alternate heating source, take the steps listed on page 45 to protect your plumbing.
- In very cold weather, the temperature of a house will drop about one degree Celsius per hour. If the power is out for a long time and you have no safe way of keeping warm, leave. Don't take the risk of getting hypothermia.
- If you leave your home, double check to make sure all heat-producing appliances such as your range and iron, are unplugged. This will minimize fire danger if power is restored while you're away.
- Gas appliances such as a hot water tank, fireplace or stove may continue to operate normally if they don't require power. Check with your gas utilities or inspector for further information.
- If the power is out for less than four hours, turn on only the most essential appliances and wait a half-hour before reconnecting others.



It's not always cold when the power goes out, but if it is, here are some additional guidelines to **prevent damage to your home's plumbing**:

- Close the water intake to your home. Protect the intake pipe, the meter or the pump by applying covers or insulating material.
- Drain all the pipes. Start on the top floor, opening all the taps and flushing the toilets several times and end in the basement, opening the drainage valve.
- Empty the hot-water tank by connecting a hose to the drainage tap of the tank so it can empty into the basement drain. Don't worry about small amounts of water that might remain in the horizontal pipes.
- Pour a little glycol or antifreeze in the toilet bowls and the drains of the sinks and bathtub to prevent freezing.

POWER GENERATORS

Consider purchasing a small generator if you live in an area that experiences cold winter temperatures or if you use life sustaining equipment. If you have a portable generator to heat your home during the power outage, be sure to connect those items that you want to run directly to the generator; do not connect the generator to your home's electrical system.

There are two types of generators for heating your home. To avoid health and safety problems, **read the manufacturer's instructions carefully** and be aware that:

- **Portable generators** are not permanently connected to the power system of a home. They can keep a limited amount of equipment operating while the main power is out. Users must make sure that the total load on the generator does not exceed the maximum load recommended by the manufacturer. Connect what you need to use directly to the generator, not to your home's electrical system. Install the generator outside your home or in the garage with the door open, to keep exhaust gas from infiltrating the house. Under no circumstances should portable generators be used indoors including inside a garage. If the outage is more than a few days, you may need to drain the oil; check to see if your brand is one in which you can do this while still operating the unit.
- **Permanent generators** are connected to the power system of a home. During outages, they start to work automatically (unless you have installed a manual throw switch). Such equipment requires a specially designed interface to keep the energy produced from leaving your house and entering the BC Hydro lines. Without this interface, lives may be at risk: those of the occupants of the building and those of the line workers working in the area. Only a professional electrician is qualified to install this type of generator and its interface.
- Some **fuel-burning devices** have a means of venting gases outdoors. If you use these devices, make sure the exhaust is not being diverted back inside. *If you*

purchase an alternate heating device, make sure it is approved for use indoors.

Camping stoves, barbecues and any equipment approved for use inside tents, all discharge carbon monoxide and are not designed for indoor use (even if you open the doors and windows). If you have a fireplace or a wood burning stove, keep a supply of wood on hand.

FALLEN POWER LINES

A fallen line may still be alive. Stay away! Don't try to free someone in contact with a line, call 911. Stay clear of anything that is or may be in contact with the line, like a fence or a tree. If a power line falls on the vehicle you are in, stay inside until help comes. If it is absolutely necessary for you to leave the vehicle (because it's on fire, for example), jump out of it with both feet together, making sure that no part of your body is touching the vehicle when you hit the ground. This technique is difficult and dangerous: that's why you should stay in the car if your life is not at risk.

HAZARDOUS MATERIALS

Hazardous material spills can seriously threaten the lives of anyone within the area. Use safety precautions whenever handling dangerous items and be sure to carefully store all your chemicals. Factories, chemical plants, pulp and paper mills, agricultural operations and transporters of dangerous goods represent some of the hazards outside the home environment. The following suggestions can help you stay informed about the dangers around you:

- Find out where reportable quantities of hazardous substances are stored and used in your community.
- Determine how close you are to freeways, railroads or factories that may produce or transport toxic materials.
- Have materials available to seal off your residence from airborne contamination.

WHEN A HAZARDOUS SPILL OCCURS

If you are caught outside, stay upstream, uphill or upwind. If you are in a car, close windows and shut off ventilation. Unless the hazardous material is flammable, emergency response professionals recommend that you stay inside (shelter in place) until you receive instructions to leave.

Once you are inside there are several things you can do to protect yourself:

- Close all outside doors and every door inside the building.
- Close all windows.
- Do not use kitchen vents or bathroom vents.

- Do not use fireplaces. Close all dampers.
- Set thermostat so air conditioners, furnaces and water heaters will not come on.
- Do not operate clothes dryer.
- Shelter in an inside room away from windows and doors if possible.
- If an explosion is imminent, close drapes, curtains and shades.
- Reduce or avoid smoking as it contaminates the air.
- Do not use the telephone, it may tie up the phone lines.
- Pay attention to local radio or TV stations for further information and follow all instructions.
- If you suspect gas or vapour contamination, take shallow breaths through a cloth or towel.
- Avoid contact with any spilled liquid materials, airborne mist or condensed solid chemical deposits. If medical help is not immediately available and you suspect contamination, remove all clothing and shower thoroughly.
- Place exposed clothing and shoes in a tightly sealed container preventing them from coming into contact with other material: get directions for proper disposal from your fire department or by calling 911. Emergency officials can also refer you to local authorities on how to clean up your land and property.
- Do not leave the building until told to, however if you must evacuate, shut vents and turn off attic fans and other ventilation systems **if there is time**.

Well weather-stripped doors and windows slow the movement of air into the buildings and any hazardous material that does enter is weakened when it mixes with the indoor air; it is imperative that you stay indoors (shelter in place), especially if you see a cloud, vapour, or smoke from the hazardous material outdoors or you can smell it from inside. You will be safer inside.

VOLCANOES

There has not been an explosive volcanic eruption in British Columbia for over 2,000 years, when Mount Meager blew. Ash from the mountain travelled as far away as southern Alberta. We don't usually think of volcanoes as being a hazard in British Columbia but in fact, the potential exists. Several mountains that can be seen every day are active (but "sleeping") volcanoes: Garibaldi, Cayley and Meager in the Whistler area and Nazko, Kostal, Tseax, Lava Fork, Hoodoo and Edziza that stretch in a belt to the Yukon border.

The greatest potential hazard to British Columbia however, is from Mount Baker in Washington State. Approximately 115 kilometres from Vancouver, much of the lower Fraser River valley would be at risk if Mount Baker erupted again as it did in 1870. It is unlikely that Mount Baker will erupt soon, but the possibility does exist.

If it does, ash falling in thick layers will suffocate plants and animals, collapse buildings and choke machinery. Ash will also wash into rivers and streams and cause them to clog with silt and change their course. Fast-moving slurries of volcanic mudflows (called lahars) are also a danger. They destroy and bury bridges and buildings as well as melting snow and ice.

It is possible that a lahar could divert the Nooksack River in Washington into the Sumas Prairie in British Columbia. This would cause the populated and productive farming area to flood extensively. Mud and silt would then flow into the Fraser River and most likely disrupt navigation downriver; possibly resulting in the flooding of low-lying areas.

PROTECTION FROM VOLCANIC ACTIVITY

Although you can't prevent a volcano from erupting, being aware of its dangers may help you to lessen some of its effects. Fortunately, a volcano will often give a period of advance warning before erupting. This is time that can be used to prepare and evacuate to safer areas and shelters.

Section 7

MOBILE HOME PREPAREDNESS

Mobile homes are more vulnerable to outside forces than homes built on concrete foundations. An earthquake can knock them off their supports, a flood can lift them off and an unprotected mobile home could be heavily damaged by a severe storm. Use the following precautions to lessen any potential damage to your mobile home:

- Leave the wheels on the coach to limit its fall.
- Check the undercarriage to make sure that it's been securely tied to the foundation. Check with the manufacturer of your mobile home for information on secure tie-down systems.
- Tie double-wide mobile homes together to keep them from pulling apart. The two halves generally are of different weights and will otherwise move differently in an earthquake or flood.
- Seismic bracing systems are commercially available. Be sure that any system you are interested in has been CSA (Canadian Standards Association) certified and inspected by the appropriate local authorities.
- Position the home near a natural windbreak such as a hill or clump of trees. As severe storms usually come in from the southwest, west, or northwest, the narrow end of your trailer should face in a westerly direction to make a smaller target.

Section 8

AFTER A DISASTER

After a major disaster, it's normal to feel helpless, worried, angry or even apathetic. You may want to be strong for others but emotional fallout is common. In the long run, you are better off sharing your distress with another supportive adult. Use the following suggestions as a guide to aid your recovery:

- Rest often, eat well and get as much physical activity as possible.
- Keep a manageable schedule; make a list and do one job at a time.
- Encourage your children to share their feelings and reassure them that they are safe.
- Watch for health problems and signs of stress in yourself and all family members.
- Take time off to do something you enjoy.
- Accept help when others are kind enough to offer.
- Share hugs liberally; the human touch is very healing.

ADDRESSING YOUR CHILDREN'S NEEDS

Children are especially vulnerable to mental and emotional distress after a disaster. Some effective ways of helping them to recover after a disaster are:

- After ensuring their physical safety, focus on your children's emotional needs by encouraging them to express their feelings. Drawing pictures and telling stories is a good way to do this. Listen carefully as they share and explain what really happened. Be honest and tell them of any further dangers that may still exist and that you will work it out together.
- As with adults, hugs are reassuring; give them liberally! Tell them things will be better again but don't lie.
- Include children in any necessary cleanup activities. Having a job to do refocuses their attention on something more positive and creates a more comforting, normal environment.
- It is common for children to revert to immature behaviour for a few days. Some normal reactions are irritability, anger, sadness, diarrhea, headache, nightmares, and loss of appetite. Praise them for sharing their feelings and for helping around the

house rather than focusing on this behaviour. However, if it persists for more than two weeks, seek professional advice.

- Be aware that for a time aspects of the disaster can trigger their fears. (Such as seeing flames or smelling smoke if there was a fire.) Talk through their fear and reassure them they are safe.
- Return to a normal schedule as soon as possible but relax the rules for a while.
- Try to spend a little extra time with them, especially at bedtime.
- Work with their teachers, childcare givers, babysitters and others who need to understand how the disaster has affected your children.

IF YOU HAD TO LEAVE YOUR HOME

If you rent or lease your home, contact the building owner or manager as soon as possible.

Contact your insurance agent or broker as soon as possible if any expenses have been incurred or if there is any insurance damage. The sooner you do this the sooner your claim will get underway. Most policies cover the cost of shelter, food and clothing for the reasonable time needed to repair or rebuild your home back to policy limits.

Section 9

WEB SITES, RESOURCES and REFERENCES

www.gov.bc.ca/for/	BC Forest Service To report a forest fire: 1-800-663-5555 or *5555 on the Telus and Rogers cellular networks
www.bchydro.com	BC Hydro To report power outages and electrical emergencies: 1-888-769-3766
www.island.net/~bcpa	BC Paraplegic Association
www.bcaa.com	British Columbia Automobile Association emergency road service: 1-800-222-4357
www.avalanche.ca	Canadian Avalanche Association
www.cmhc-schl.gc.ca	Canadian Housing Information Centre
www.cnib.ca	Canadian National Institute for the Blind
www.canparaplegic.org	Canadian Paraplegic Association
www.redcross.ca	Canadian Red Cross
www.centragas.com	Centra Gas
www.city.vancouver.bc.ca/corpsvcs/emerg/	City of Vancouver Emergency Program
www.vep.city.victoria.bc.ca	City of Victoria Emergency Program
www.jibc.bc.ca/	Justice Institute of B.C.
www.gov.bc.ca/healthplanning/	Ministry of Health Planning
www.gov.bc.ca/healthservices/	Ministry of Health Services
www.ess.bc.ca	Ministry of Human Resources, Emergency Social Services
www.th.gov.bc.ca/bchighways	Ministry of Transportation
www.pgc.nrcan.gc.ca	Natural Resources Canada

www.epc-pcc.gc.ca	Office of Critical Infrastructure Protection and Emergency Preparedness: 1-800-668-2642
www.parkscanada.pch.gc.ca	Parks Canada
www.pep.bc.ca	Provincial Emergency Program Emergency reporting Line: 1-800-663-3456 Recorded Information Line: 1-888-811-6233
www.percs.bc.ca	Provincial Emergency Radio Communications Service
www.rac.ca	Radio Amateurs of Canada
www.safeguard.ca/english/	Safeguard (Emergency Preparedness Partners) 1-800-830-3118
www.scecdc.scec.org	Southern California Earthquake Data Centre
www.sja.ca	St. John Ambulance
www.telus.com/cgi-ebs/homepage.jsp	Telus (Public Policy/Disaster Planning) <i>(Look in the front of your phonebook for basic first aid and safety information)</i>
www.westcoastenergy.com/index.html	Westcoast Energy Inc.

ADDITIONAL SOURCES OF INFORMATION

- British Columbia Veterinary Medical Association
- Fire Departments
- Insurance agents
- Local government emergency coordinators
- Local utility suppliers
- Ministry of Community, Aboriginal and Women's Services, Boiler, Gas and Railway Safety Branch
- Municipal Neighbourhood Programs
- Plumbers, gas appliance dealers and gas fitters
- Supply stores such as building supplies, glass stores



Provincial Emergency Program Web site:
www.pep.bc.ca

Toll-free, recorded message line:
1-888-811-6233



**Ministry of Public Safety
and Solicitor General**